

NV9 USB+

- 'The next generation banknote validator'

- **Exceptional field reliability**
- **Enhanced sensing technology**
- **Cashbox & bezel options to suit all applications**
- **Future proof**
- **Add on recycler available**



Features

various cashbox and bezel options

proven field reliability

enhanced sensing technology = high acceptance rate for multi-currency

easy maintenance, free firmware updates

over 100 different world currencies accepted

optional note float unit

Benefits

versatile validator, suitable for all applications

lowest cost of ownership

takes more cash

future proof - quick & easy updates via USB, PC or handheld programmer

a truly global product

ability to add note recycling



Innovative Technology
INTELLIGENCE IN VALIDATION



Bellis Technology
INTELLIGENCE IN VALIDATION

Technical Specification

NV9 USB+

Power

Requirements: 12 V
Standby: 0.2 A
Running: 1 A
Peak: 1.5 A

Bezel Options

66 / 69 / 82 mm width
Horizontal
Vertical up / down
Various snout options
Rainbow illumination

Cashbox Options

300 / 600 slide
300 / 600 clip
300 lockable

Protocols

SSP
ccTalk
MDB
Pulse
Parallel
Binary
Serial

Interfaces

USB
Open collector

MCBF

200,000

Office Locations

Head Office

Innovative Technology Ltd. (UK)
Innovative Business Park
Derker Street, Oldham OL1 4EQ
T: +44 (0) 161 626 9999
E: sales@innovative-technology.co.uk

Innovative Technology (Spain)

T: +34 933 600 330
E: salesES@innovative-technology.eu

Innovative Technology (Germany)

T: +49 4101 58580
E: salesDE@innovative-technology.eu

Innovative Technology (Italy)

T: +39 348 7376 331
E: salesIT@innovative-technology.eu

Innovative Technology (China)

T: +86 755 2531 0169
E: sales@innovative-technology.co.uk

Innovative Technology (Asia Pacific)

T: +61 7 3842 3126
E: sales@innovative-technology.com.au

Bellis Tecnologia (Brazil)

T: +55 11 4513 6479
E: sales@bellis-technology.com.br

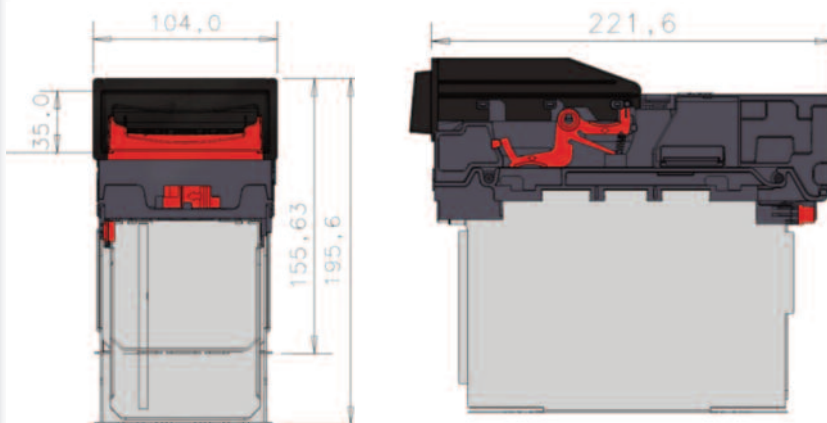

Weight: 1.7 kg



Technical Information



www.innovative-technology.co.uk

NV9 USB+ Bezel & Cashbox Options

NV9 USB+101



Cash Box: 300 Slide In (PA192)
Bezel: Horizontal (PA189)

NV9 USB+201



Cash Box: 600 Slide In (PA194)
Bezel: Horizontal (PA189)

NV9 USB+302

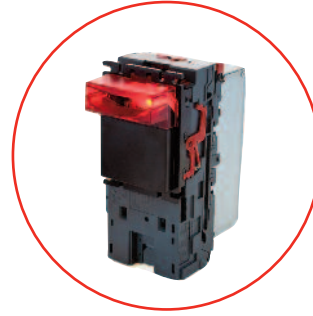

Cash Box: 300 Clip On (PA185)
Bezel: Vertical Down Snout (PA191)

NV9 USB+402

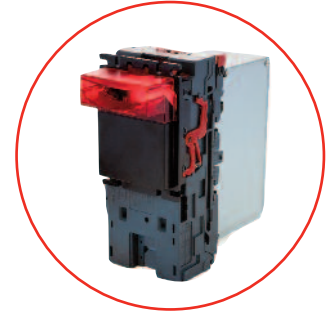

Cash Box: 600 Clip On (PA193)
Bezel: Vertical Down Snout (PA191)

NV9 USB+102

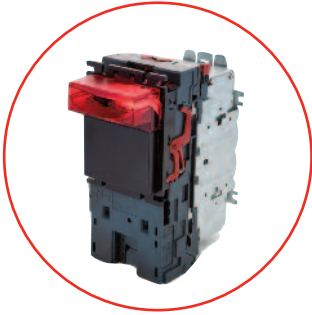

Cash Box: 300 Slide In (PA192)
Bezel: Vertical Down Snout (PA191)

NV9 USB+202

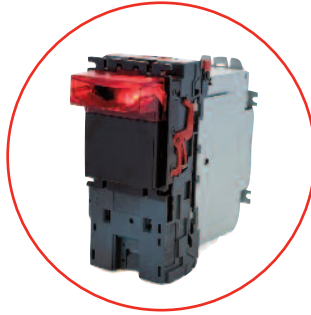

Cash Box: 600 Slide In (PA194)
Bezel: Vertical Down Snout (PA191)

NV9 USB+303

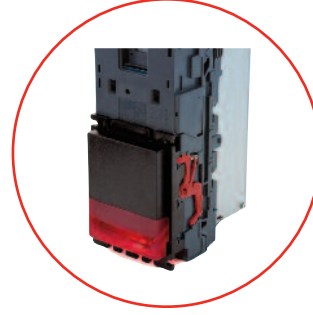

Cash Box: 300 Clip On (PA185)
Bezel: Vertical Up (PA188)

NV9 USB+403

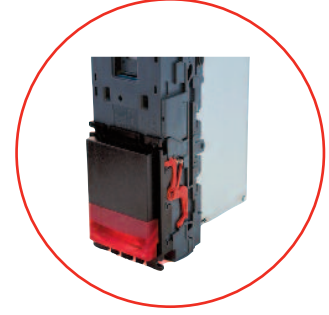

Cash Box: 600 Clip On (PA193)
Bezel: Vertical Up (PA188)

NV9 USB+103

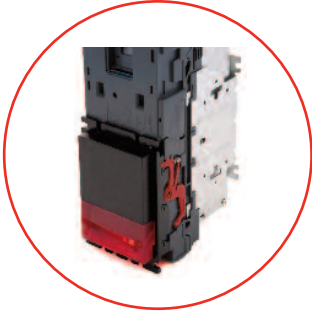

Cash Box: 300 Slide In (PA192)
Bezel: Vertical Up (PA188)

NV9 USB+203

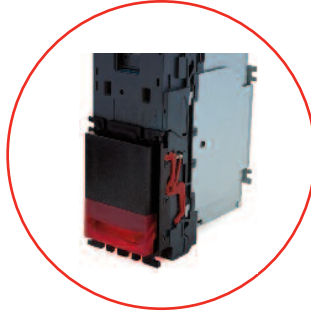

Cash Box: 600 Slide In (PA194)
Bezel: Vertical Up (PA188)

NV9 USB+304

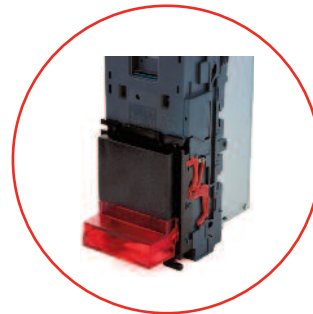

Cash Box: 300 Clip On (PA185)
Bezel: Vertical Up Snout (PA190)

NV9 USB+404

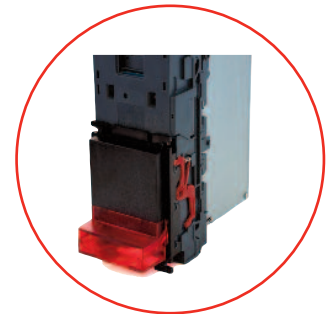

Cash Box: 600 Clip On (PA193)
Bezel: Vertical Up Snout (PA190)

NV9 USB+104

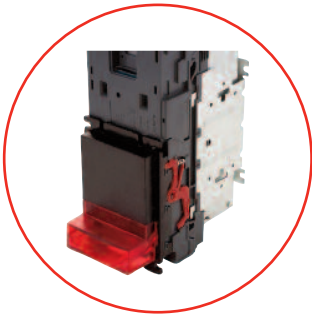

Cash Box: 300 Slide In (PA192)
Bezel: Vertical Up Snout (PA190)

NV9 USB+204

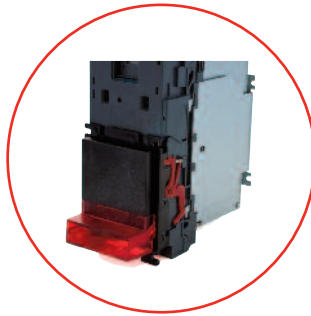

Cash Box: 600 Slide In (PA194)
Bezel: Vertical Up Snout (PA190)

NV9 USB+501 (Lockable)



Locking Door
Position 1

Cash Box: 300 Lockable (PA186)
Door: Front Right (Standard)

NV9 USB+601

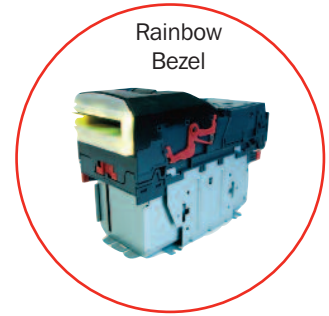

Rainbow
Bezel

Bezel: Rainbow (PA01144)



Innovative Technology
INTELLIGENCE IN VALIDATION



Bellis Technology
INTELLIGENCE IN VALIDATION